

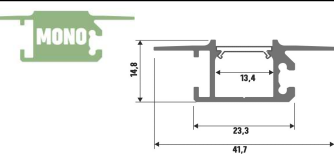

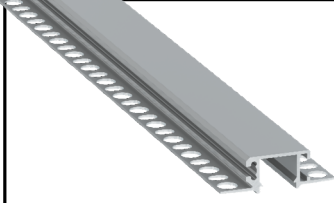



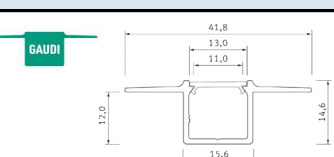
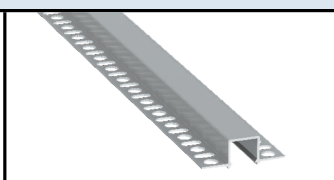

ARCHITECTURAL PROFILES - GROUP II

Description	Photo	Colour	Index		
LUMINES Profile type MONO					
		silver anodized	10-0684-10		
		black lacquered	10-0685-10		
		white lacquered	10-0681-10		
<p align="center">End Caps LUMINES MONO [with hole]</p>		Aluminium End Caps with hole left			
		silver	12-1235-10		
		black	12-0000-17		
		white	12-1231-10		
		Aluminium End Caps with hole right			
		silver	12-1245-10		
		black	12-0000-18		
		white	12-1241-10		
		Plastic End Caps with hole			
		gray	12-1084-00		
		black	12-1082-00		
		white	12-1081-00		
silver lacquered	12-1285-01				
Profil LUMINES type GAUDI					
		raw	10-0980-10		
		silver anodized	10-0974-10		
		black lacquered	10-0965-10		
		white lacquered	10-0951-10		
<p align="center">End Caps LUMINES GAUDI [with hole]</p>		Plastic End Caps with hole			
		silver	12-1044-00		
		black	12-1042-00		
		white	12-1041-00		
		silver lacquered	12-1045-01		
LUMINES Profile type ZATI					
		silver anodized	10-0594-10		
		black lacquered	10-0595-10		
		white lacquered	10-0591-10		
		Aluminium End Caps with hole left			
		silver	12-0905-10		
		black	12-0000-51		

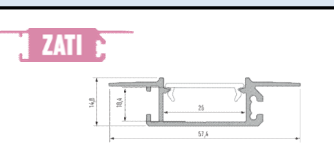
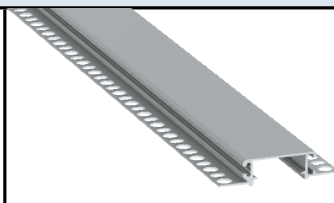
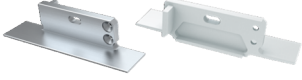

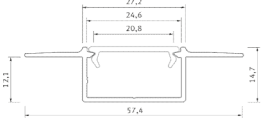
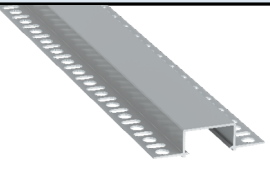
End Caps LUMINES ZATI [with hole]		white	12-0901-10			
		Aluminium End Caps with hole right				
		silver	12-0915-10			
		black	12-0000-52			
		white	12-0911-10			
		Plastic End Caps with hole				
		gray	12-1074-00			
		black	12-1072-00			
		white	12-1071-00			
		silver lacquered	12-1075-01			

Profil LUMINES type HIRO

 		raw	10-0860-10		
		silver anodized	10-0854-10		
		black lacquered	10-0845-10		
		white lacquered	10-0831-10		
		Plastic End Caps with hole			

End Caps LUMINES HIRO [with hole]		Plastic End Caps with hole			
		silver	12-1014-00		
		black	12-1012-00		
		white	12-1011-00		
		silver lacquered	12-1015-01		

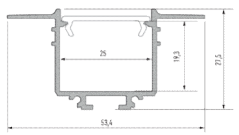
LUMINES Profile type SUBLI

 		silver anodized	10-0554-10		
		black lacquered	10-0555-10		
		white lacquered	10-0551-10		



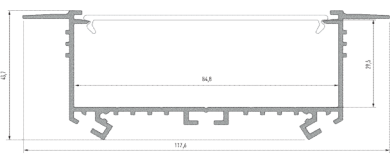
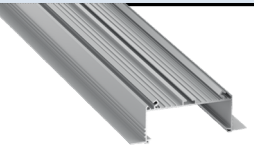

End Caps LUMINES SUBLI [with hole]		Aluminium End Caps with hole			
		silver	12-0665-10		
		black	12-0662-10		
		white	12-0661-10		

LUMINES Profile type SORGA

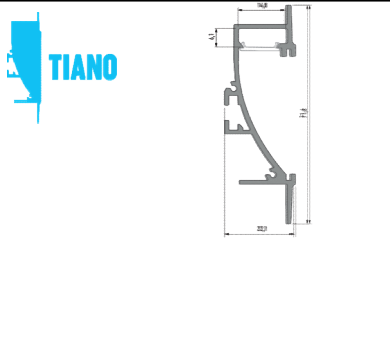

 		silver anodized	10-0534-10			
		ON REQUEST NA ZAKOWIENIE ✓	black lacquered	10-0765-10		
		white lacquered	10-0531-10			







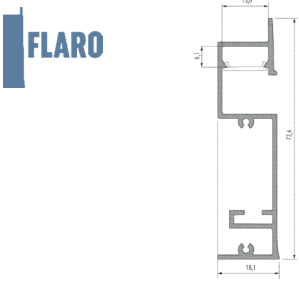
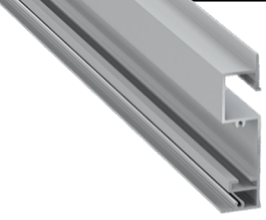

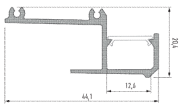

End Caps LUMINES SORGA [with hole]		Aluminium End Caps with hole			
		silver	12-0655-10		
		black	12-0000-22		
		white	12-0651-10		

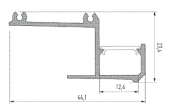
LUMINES Profile type TIANO

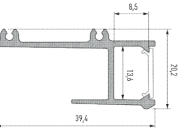
		<p>silver anodized</p> <p>10-0564-10</p>		
		<p>ON REQUEST NA ZAMOWIENIE ✓</p> <p>black lacquered</p> <p>10-1525-10</p>		
		<p>white lacquered</p> <p>10-0561-10</p>		
<p>End Caps straight LUMINES TIANO [with hole, without hole]</p>		<p>Aluminium End Caps left</p>		
		<p>silver</p> <p>12-0835-11</p>		
		<p>black</p> <p>12-0842-11</p>		
		<p>white</p> <p>12-0831-11</p>		
		<p>Aluminium End Caps with hole left</p>		
		<p>silver</p> <p>12-0835-10</p>		
		<p>black</p> <p>12-0822-10</p>		
		<p>white</p> <p>12-0831-10</p>		
		<p>Aluminium End Caps right</p>		
		<p>silver</p> <p>12-0845-11</p>		
		<p>black</p> <p>12-0842-10</p>		
		<p>white</p> <p>12-0841-11</p>		
<p>Aluminium End Caps with hole right</p>				
<p>silver</p> <p>12-0845-10</p>				
<p>black</p> <p>12-0802-10</p>				
<p>white</p> <p>12-0841-10</p>				
<p>End Caps built-in LUMINES TIANO [with hole]</p>		<p>Aluminium End Caps with hole left</p>		
		<p>silver</p> <p>12-0815-10</p>		
		<p>black</p> <p>12-0812-10</p>		
		<p>white</p> <p>12-0811-10</p>		
		<p>Aluminium End Caps with hole right</p>		
		<p>silver</p> <p>12-0825-10</p>		
<p>black</p> <p>12-0832-10</p>				
<p>white</p> <p>12-0821-10</p>				

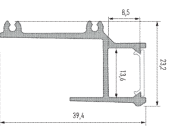
LUMINES Profile type FLARO

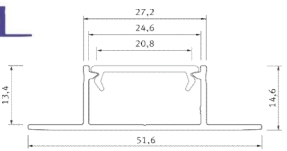
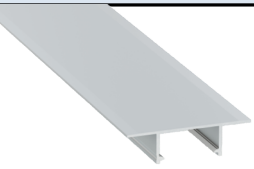
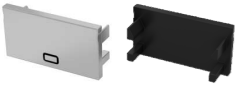
		<table border="1"> <tr> <td>silver anodized</td> <td>10-0444-10</td> <td></td> <td></td> </tr> </table>	silver anodized	10-0444-10				
silver anodized	10-0444-10							
		<table border="1"> <tr> <td>ON REQUEST NA ZAMOWIENIE ✓</td> <td>black lacquered</td> <td>10-0441-10</td> <td></td> </tr> </table>	ON REQUEST NA ZAMOWIENIE ✓	black lacquered	10-0441-10			
ON REQUEST NA ZAMOWIENIE ✓	black lacquered	10-0441-10						
		<table border="1"> <tr> <td>white lacquered</td> <td>10-0441-10</td> <td></td> <td></td> </tr> </table>	white lacquered	10-0441-10				
white lacquered	10-0441-10							
<p>End Caps straight LUMINES FLARO [with hole, without hole]</p>		Aluminium End Caps left						
		<table border="1"> <tr> <td>silver</td> <td>12-0255-11</td> <td></td> <td></td> </tr> </table>	silver	12-0255-11				
		silver	12-0255-11					
		<table border="1"> <tr> <td>black</td> <td>12-0000-07</td> <td></td> <td></td> </tr> </table>	black	12-0000-07				
		black	12-0000-07					
		<table border="1"> <tr> <td>white</td> <td>12-0231-11</td> <td></td> <td></td> </tr> </table>	white	12-0231-11				
		white	12-0231-11					
		Aluminium End Caps with hole left						
		<table border="1"> <tr> <td>silver</td> <td>12-0255-10</td> <td></td> <td></td> </tr> </table>	silver	12-0255-10				
		silver	12-0255-10					
		<table border="1"> <tr> <td>black</td> <td>12-0922-10</td> <td></td> <td></td> </tr> </table>	black	12-0922-10				
		black	12-0922-10					
<table border="1"> <tr> <td>white</td> <td>12-0231-10</td> <td></td> <td></td> </tr> </table>	white	12-0231-10						
white	12-0231-10							
Aluminium End Caps right								
<table border="1"> <tr> <td>silver</td> <td>12-0245-11</td> <td></td> <td></td> </tr> </table>	silver	12-0245-11						
silver	12-0245-11							
<table border="1"> <tr> <td>black</td> <td>12-0000-08</td> <td></td> <td></td> </tr> </table>	black	12-0000-08						
black	12-0000-08							
<table border="1"> <tr> <td>white</td> <td>12-0241-11</td> <td></td> <td></td> </tr> </table>	white	12-0241-11						
white	12-0241-11							
Aluminium End Caps with hole right								
<table border="1"> <tr> <td>silver</td> <td>12-0245-10</td> <td></td> <td></td> </tr> </table>	silver	12-0245-10						
silver	12-0245-10							
<table border="1"> <tr> <td>black</td> <td>12-0932-10</td> <td></td> <td></td> </tr> </table>	black	12-0932-10						
black	12-0932-10							
<table border="1"> <tr> <td>white</td> <td>12-0241-10</td> <td></td> <td></td> </tr> </table>	white	12-0241-10						
white	12-0241-10							
<p>End Caps built-in LUMINES FLARO [with hole]</p>		Aluminium End Caps with hole left						
		<table border="1"> <tr> <td>silver</td> <td>12-0215-10</td> <td></td> <td></td> </tr> </table>	silver	12-0215-10				
		silver	12-0215-10					
		<table border="1"> <tr> <td>black</td> <td>12-0212-10</td> <td></td> <td></td> </tr> </table>	black	12-0212-10				
		black	12-0212-10					
		<table border="1"> <tr> <td>white</td> <td>12-0211-10</td> <td></td> <td></td> </tr> </table>	white	12-0211-10				
		white	12-0211-10					
Aluminium End Caps with hole right								
<table border="1"> <tr> <td>silver</td> <td>12-0235-10</td> <td></td> <td></td> </tr> </table>	silver	12-0235-10						
silver	12-0235-10							
<table border="1"> <tr> <td>black</td> <td>12-0222-10</td> <td></td> <td></td> </tr> </table>	black	12-0222-10						
black	12-0222-10							
<table border="1"> <tr> <td>white</td> <td>12-0221-10</td> <td></td> <td></td> </tr> </table>	white	12-0221-10						
white	12-0221-10							

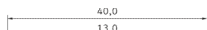
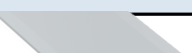
LUMINES Profile type IPA12						
 		silver anodized	10-0484-10			
		black lacquered	10-0405-10			
		white lacquered	10-0481-10			
LUMINES Profile type IPA16						
 		silver anodized	10-0494-10			
		ON REQUEST NA ZAMOWIENIE ✓	black lacquered	10-0415-10		
		white lacquered	10-0491-10			
LUMINES Profile type APA12						
 		silver anodized	10-0404-10			
		black lacquered	10-0315-10			
		white lacquered	10-0401-10			
LUMINES Profile type APA16						
 		silver anodized	10-0414-10			
		ON REQUEST NA ZAMOWIENIE ✓	black lacquered	10-0325-10		
		white lacquered	10-0411-10			
Profil LUMINES type PLATO						
 		raw	10-0900-10			
		silver anodized	10-0894-10			
		black lacquered	10-0885-10			
		white lacquered	10-0871-10			
End Caps LUMINES PLATO [2in1 push hole]		Plastic End Caps (2in1 push hole)				
		silver	12-1024-01			
		black	12-1022-01			
		white	12-1021-01			
		silver lacquered	12-1125-01			
Profil LUMINES type FALCO						
 		raw	10-0940-10			

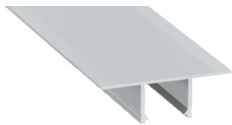
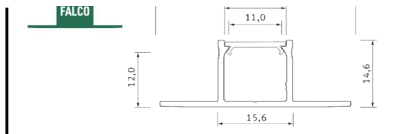





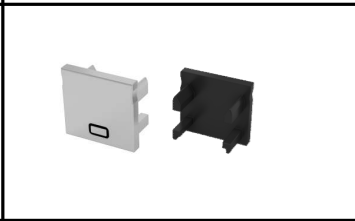





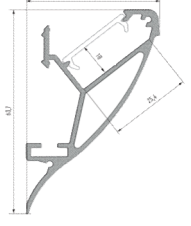
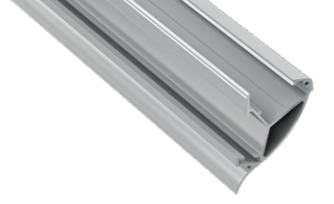
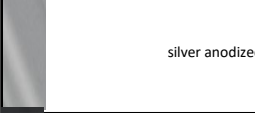
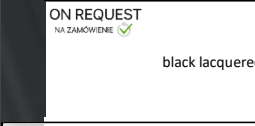
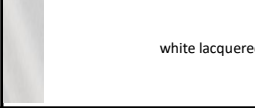

	silver anodized	10-0934-10		
	black lacquered	10-0925-10		
	white lacquered	10-0911-10		

End Caps LUMINES FLACO
[2in1 push hole]









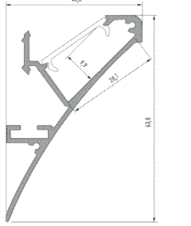
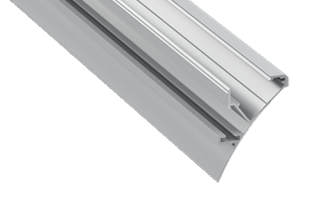

Plastic End Caps (2in1 push hole)				
	silver	12-1034-01		
	black	12-1032-01		
	white	12-1031-01		
	silver lacquered	12-1035-01		

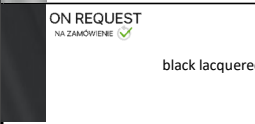
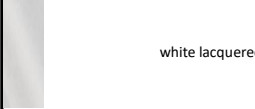
LUMINES Profile type CONVA

 			silver anodized 10-0424-10			
			black lacquered 10-1335-10			
			white lacquered 10-0421-10			
End Caps LUMINES CONVA [with hole, without hole]		Aluminium End Caps left				
			silver 12-0155-11			
			black 12-0152-11			
			white 12-0151-11			
		Aluminium End Caps with hole left				
			silver 12-0155-10			
			black 12-0152-10			
			white 12-0151-10			
		Aluminium End Caps right				
			silver 12-0165-11			
			black 12-0162-11			
			white 12-0161-11			
		Aluminium End Caps with hole right				
	silver 12-0165-10					
	black 12-0162-10					
	white 12-0161-10					

LUMINES Profile type LOGI

 			silver anodized 10-0504-10			
			black lacquered 10-0455-10			
			white lacquered 10-0501-10			
End Caps LUMINES LOGI		Aluminium End Caps left				
			silver 12-0525-11			
			black 12-0000-15			
			white 12-0521-11			
		Aluminium End Caps with hole left				
			silver 12-0525-10			
			black 12-0522-10			
	white 12-0521-10					

[with hole, without hole]



Aluminium End Caps right

silver	12-0535-11		
black	12-0000-16		
white	12-0531-11		

Aluminium End Caps with hole right

silver	12-0535-10		
black	12-0532-10		
white	12-0531-10		

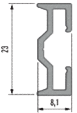

Mounting profile SPARO for profiles
CONVA, LOGI

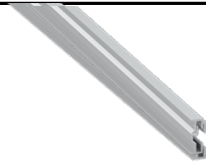

silver anodized	10-0544-10		
-----------------	------------	--	--

LUMINES Profile type TOPO

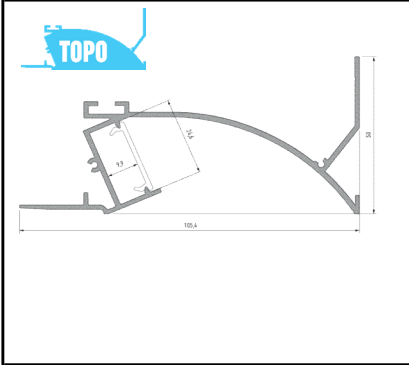

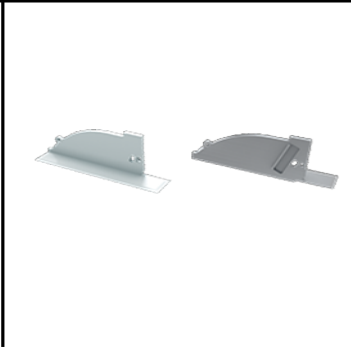

silver anodized	10-0574-10		
ON REQUEST <small>NA ZAMOWIENIE</small> ✓	black lacquered	10-0565-10	
white lacquered	10-0571-10		

End Caps LUMINES TOPO
[with hole]



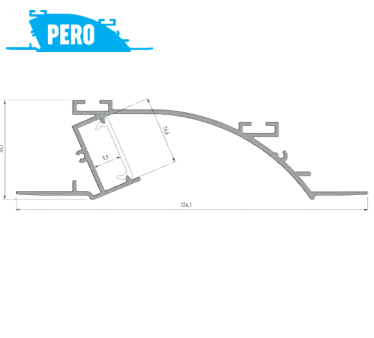

Aluminium End Caps with hole left			
silver	12-0855-10		
black	12-0862-10		
white	12-0851-10		
Aluminium End Caps with hole right			
silver	12-0865-10		
black	12-0852-10		
white	12-0861-10		

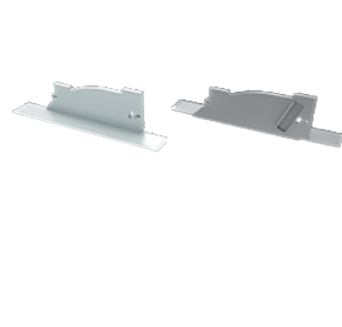
LUMINES Profile type PERO

		silver anodized	10-0514-10			
		ON REQUEST NA ZAMOWIENIE ✓	black lacquered	10-0475-10		
		white lacquered	10-0511-10			
<p>End Caps LUMINES PERO [with hole]</p>		Aluminium End Caps with hole left				
		silver	12-0555-10			
		black	12-0552-10			
		white	12-0551-10			
		Aluminium End Caps with hole right				
		silver	12-0565-10			
black	12-0562-10					
white	12-0561-10					

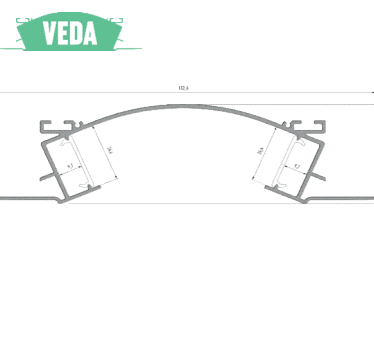
LUMINES Profile type VEDA

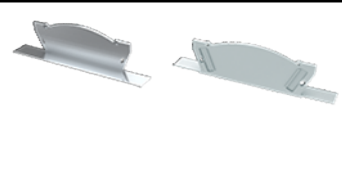
		silver anodized	10-0584-10			
		ON REQUEST NA ZAMOWIENIE ✓	black lacquered	10-0575-10		
		white lacquered	10-0581-10			
<p>End Caps LUMINES VEDA [with hole]</p>		Aluminium End Caps with hole				
		silver	12-0895-10			
		black	12-0902-10			
		white	12-0891-10			

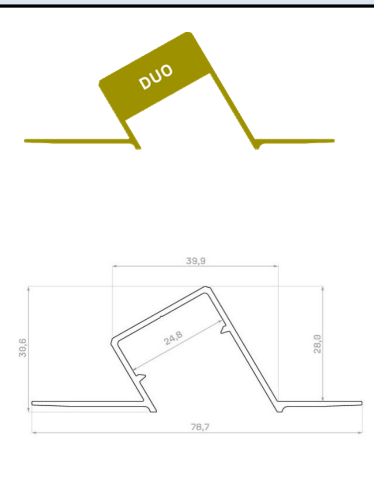
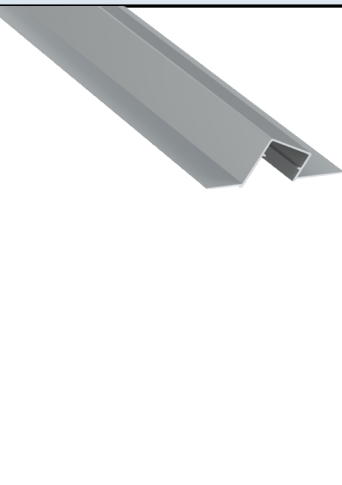

LUMINES Profile type DUO

		silver anodized	10-1154-10		
		black lacquered	10-1155-10		
		white lacquered	10-1151-10		
		Raw	10-1150-10		

Plastic End Caps with hole left

Zaślepki LUMINES DUO
[z otworem]









grey	12-1344-00		
black	12-1342-00		
white	12-1341-00		
silver lacquered	12-1345-00		
Plastic End Caps with hole right			
grey	12-1354-00		
black	12-1352-00		
white	12-1351-00		
silver lacquered	12-1355-00		
Aluminium End Caps with hole left			
white lacquered	12-1431-10		
black lacquered	12-1432-10		
silver lacquered	12-1435-10		
Aluminium End Caps with hole right			
white lacquered	12-1421-10		
black lacquered	12-1422-10		
silver lacquered	12-1425-10		

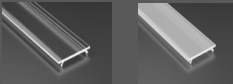

ACCESSORIES

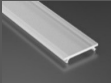
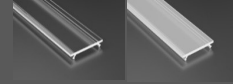

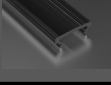

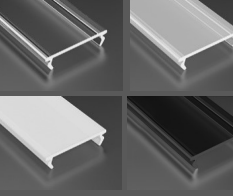

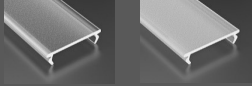
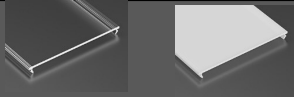
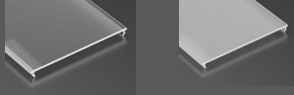
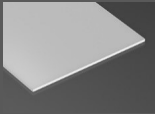
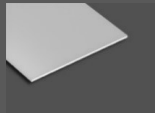
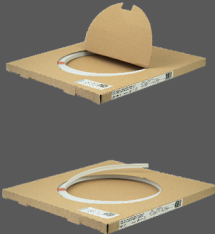
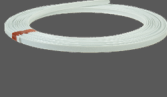

LUMINES COVER

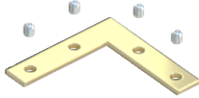
Tolerance levels of the dimension (section length) for covers are
1m ; 2,02m ; 3m is 5mm. For sections over 3m +8mm

Description	Photo	Colour	Index		
Cover LUMINES BASIC V2 PMMA		transparent	11-2213-10		
		frozen	11-2212-10		
For profiles [APA12, APA16, IPA12, IPA16, FLARO ,MONO, TIANO, GAUDI, FALCO]		milky	11-2211-10		
		 black	11-2217-10		
Cover LUMINES BASIC V2 PMMA FROSTED		frosted ML	11-2216-10		
For profiles [APA12, APA16, IPA12, IPA16, FLARO ,MONO, TIANO, GAUDI, FALCO]					
Cover LUMINES BASIC PC		transparent	11-3013-10		
		frozen	11-3012-10		
For profiles [APA12, APA16, IPA12, IPA16, FLARO ,MONO, TIANO, GAUDI, FALCO]		milky	11-3011-10		
Cover LUMINES BASIC V2 FRACTAL PC		clear	11-3213-10		
		opal	11-3211-10		
For profiles [APA12, APA16, IPA12, IPA16, FLARO ,MONO, TIANO, GAUDI, FALCO]		 black	11-3347-10		
Cover LUMINES DOUBLE PMMA		transparent	11-2073-10		
		frozen	11-2072-10		
		milky	11-2071-10		
		black	11-2077-10		
For profiles [SUBLI, ZATI, LOGI, CONVA, TOPO, PERO, VEDA, HIRO, PLATO, DUO]					

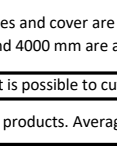
Cover LUMINES DOUBLE PMMA FROSTED		frosted (do wyczerpania zapasów)	11-2075-10		
For profiles [SUBLI, ZATI, LOGI, CONVA, TOPO, PERO, VEDA, HIRO, PLATO]		frosted ML	11-2076-10		
Cover LUMINES SUPER WIDE PMMA		transparent	11-2093-10		
For profile [SORGA]		milky	11-2091-10		
Cover LUMINES SUPER WIDE PMMA FROSTED		frosted (do wyczerpania zapasów)	11-2095-10		
For profile [SORGA]		frosted ML	11-2096-10		
Cover LUMINES SUPER WIDE PLEXI					
For profile [SORGA]		PLEXI	11-3091-10		
Cover LUMINES TIANO PLEXI					
For profile [TIANO]		PLEXI	11-3111-10		
LUMINES COVER - 20m packaging					
Description	Photo	Colour	Index		
Cover LUMINES BASIC PMMA - 20m		transparent	11-2043-22		
		frozed	11-2042-22		
		milky	11-2041-22		
For profiles [APA12, APA16, IPA12, IPA16, FLARO, MONO, TIANO, GAUDI, FALCO]		frosted ML	11-2046-22		
Cover LUMINES BASIC PC - 20m		transparent	11-3043-22		
		frozed	11-3042-22		
		milky	11-3041-22		
For profiles [APA12, APA16, IPA12, IPA16, FLARO, MONO, TIANO, GAUDI, FALCO]					

ACCESSORIES

<p>Mounting spring [For profiles inSILEDA, inDILEDA, TALIA M3, TALIA M4, inTALIA, LARGO M3, LARGO M4, TIANO, SUBLI, SORGA, TOPO, PERO, VEDA]</p>		galvanized steel	14-5001-00		
<p>LUMINES Connectors</p>		angular (without allen)	14-3030-01		
		angular (with allen)	14-3031-01		
		straight (without allen)	14-3032-02		
		straight (with allen)	14-3030-02		
		angular cross (without allen)	14-3038-01		
		angular cross (with allen)	14-3039-01		
		angular 120 degree (without allen)	14-3036-01		
		angular 120 degree (with allen)	14-3037-01		

** The profiles and cover are available in sizes: 1000 mm, 2020 mm
 *** Dimensions of 3000 mm and 4000 mm are also available after prior consultation with the distributor

It is possible to cut profiles to any dimension

ON REQUEST
NA ZAMOWIENIE

Custom-made products. Average delivery time 14-21 days, after confirmation with the distributor.

Distributor:

Orders: