

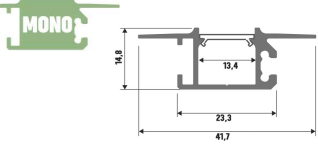





ARCHITECTURAL PROFILES - GROUP II

Description	Photo	Colour	Index		
LUMINES Profile type MONO					
		silver anodized	10-0684-10		
		black lacquered	10-0685-10		
		white lacquered	10-0681-10		
<p align="center">End Caps LUMINES MONO [with hole]</p>		Aluminium End Caps with hole left			
		silver	12-1235-10		
		black	12-0000-17		
		white	12-1231-10		
		Aluminium End Caps with hole right			
		silver	12-1245-10		
	black	12-0000-18			
	white	12-1241-10			
	 <p align="right">★ NEW</p>	Plastic End Caps with hole			
		gray	12-1084-00		
black		12-1082-00			
white	12-1081-00				
Profil LUMINES type GAUDI					
	 <p align="right">★ NEW</p>	raw	10-0980-10		
		silver anodized	10-0974-10		
		black lacquered	10-0965-10		
		white lacquered	10-0951-10		
<p align="center">End Caps LUMINES GAUDI [with hole]</p>		Plastic End Caps with hole			
		silver	12-1044-00		
		black	12-1042-00		
		white	12-1041-00		
LUMINES Profile type ZATI					
		silver anodized	10-0594-10		
		black lacquered	10-0595-10		
		white lacquered	10-0591-10		
<p align="center">End Caps LUMINES ZATI</p>		Aluminium End Caps with hole left			
		silver	12-0905-10		
		black	12-0000-51		
		white	12-0901-10		
		Aluminium End Caps with hole right			
silver	12-0915-10				

[with hole]		black	12-0000-52		
		white	12-0911-10		
Plastic End Caps with hole					
		gray	12-1074-00		
		black	12-1072-00		
		white	12-1071-00		

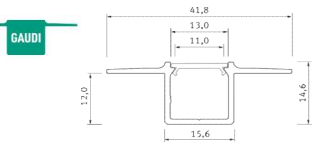
Profil LUMINES type HIRO

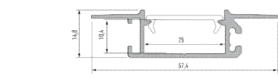
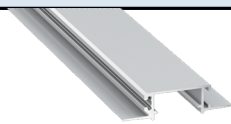
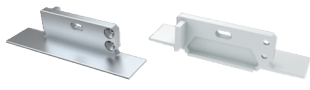
		raw	10-0860-10		
		silver anodized	10-0854-10		
		black lacquered	10-0845-10		
		white lacquered	10-0831-10		

End Caps LUMINES HIRO [with hole]		Plastic End Caps with hole			
		silver	12-1014-00		
		black	12-1012-00		
		white	12-1011-00		

LUMINES Profile type SUBLI

		silver anodized	10-0554-10		
		black lacquered	10-0555-10		
		white lacquered	10-0551-10		



End Caps LUMINES SUBLI [with hole]		Aluminium End Caps with hole			
		silver	12-0665-10		
		black	12-0662-10		
		white	12-0661-10		

LUMINES Profile type SORGA



		silver anodized	10-0534-10		
		black lacquered	10-0765-10		
		white lacquered	10-0531-10		

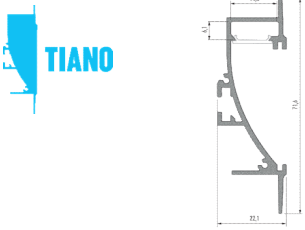
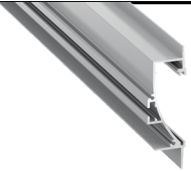





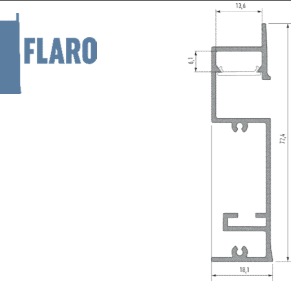
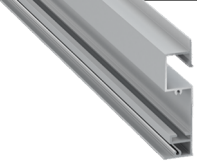



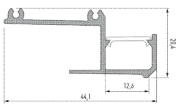



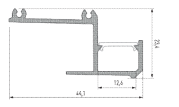



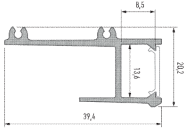

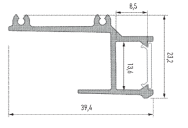

End Caps LUMINES SORGA [with hole]		Aluminium End Caps with hole			
		silver	12-0655-10		
		black	12-0000-22		
		white	12-0651-10		

LUMINES Profile type TIANO

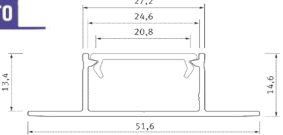
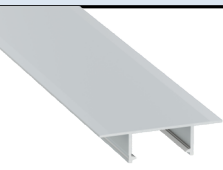
		<table border="1"> <tr> <td>silver anodized</td> <td>10-0564-10</td> <td></td> <td></td> </tr> </table>	silver anodized	10-0564-10																																																																																
silver anodized	10-0564-10																																																																																			
<p>End Caps straight LUMINES TIANO [with hole, without hole]</p>		<table border="1"> <tr> <td colspan="4">Aluminium End Caps left</td> </tr> <tr> <td>silver</td> <td>12-0835-11</td> <td></td> <td></td> </tr> <tr> <td>black</td> <td>12-0842-11</td> <td></td> <td></td> </tr> <tr> <td>white</td> <td>12-0831-11</td> <td></td> <td></td> </tr> </table>	Aluminium End Caps left				silver	12-0835-11			black	12-0842-11			white	12-0831-11																																																																				
Aluminium End Caps left																																																																																				
silver	12-0835-11																																																																																			
black	12-0842-11																																																																																			
white	12-0831-11																																																																																			
<p>End Caps built-in LUMINES TIANO [with hole]</p>		<table border="1"> <tr> <td colspan="4">Aluminium End Caps with hole left</td> </tr> <tr> <td>silver</td> <td>12-0835-10</td> <td></td> <td></td> </tr> <tr> <td>black</td> <td>12-0822-10</td> <td></td> <td></td> </tr> <tr> <td>white</td> <td>12-0831-10</td> <td></td> <td></td> </tr> <tr> <td colspan="4">Aluminium End Caps right</td> </tr> <tr> <td>silver</td> <td>12-0845-11</td> <td></td> <td></td> </tr> <tr> <td>black</td> <td>12-0842-10</td> <td></td> <td></td> </tr> <tr> <td>white</td> <td>12-0841-11</td> <td></td> <td></td> </tr> <tr> <td colspan="4">Aluminium End Caps with hole right</td> </tr> <tr> <td>silver</td> <td>12-0845-10</td> <td></td> <td></td> </tr> <tr> <td>black</td> <td>12-0802-10</td> <td></td> <td></td> </tr> <tr> <td>white</td> <td>12-0841-10</td> <td></td> <td></td> </tr> <tr> <td colspan="4">Aluminium End Caps with hole left</td> </tr> <tr> <td>silver</td> <td>12-0815-10</td> <td></td> <td></td> </tr> <tr> <td>black</td> <td>12-0812-10</td> <td></td> <td></td> </tr> <tr> <td>white</td> <td>12-0811-10</td> <td></td> <td></td> </tr> <tr> <td colspan="4">Aluminium End Caps with hole right</td> </tr> <tr> <td>silver</td> <td>12-0825-10</td> <td></td> <td></td> </tr> <tr> <td>black</td> <td>12-0832-10</td> <td></td> <td></td> </tr> <tr> <td>white</td> <td>12-0821-10</td> <td></td> <td></td> </tr> </table>	Aluminium End Caps with hole left				silver	12-0835-10			black	12-0822-10			white	12-0831-10			Aluminium End Caps right				silver	12-0845-11			black	12-0842-10			white	12-0841-11			Aluminium End Caps with hole right				silver	12-0845-10			black	12-0802-10			white	12-0841-10			Aluminium End Caps with hole left				silver	12-0815-10			black	12-0812-10			white	12-0811-10			Aluminium End Caps with hole right				silver	12-0825-10			black	12-0832-10			white	12-0821-10				
Aluminium End Caps with hole left																																																																																				
silver	12-0835-10																																																																																			
black	12-0822-10																																																																																			
white	12-0831-10																																																																																			
Aluminium End Caps right																																																																																				
silver	12-0845-11																																																																																			
black	12-0842-10																																																																																			
white	12-0841-11																																																																																			
Aluminium End Caps with hole right																																																																																				
silver	12-0845-10																																																																																			
black	12-0802-10																																																																																			
white	12-0841-10																																																																																			
Aluminium End Caps with hole left																																																																																				
silver	12-0815-10																																																																																			
black	12-0812-10																																																																																			
white	12-0811-10																																																																																			
Aluminium End Caps with hole right																																																																																				
silver	12-0825-10																																																																																			
black	12-0832-10																																																																																			
white	12-0821-10																																																																																			

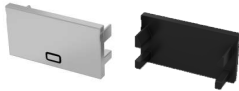
LUMINES Profile type FLARO

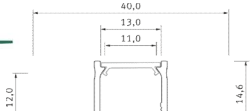
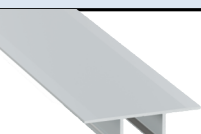
		<table border="1"> <tr> <td>silver anodized</td> <td>10-0444-10</td> <td></td> <td></td> </tr> <tr> <td>black lacquered</td> <td>10-0441-10</td> <td></td> <td></td> </tr> <tr> <td>white lacquered</td> <td>10-0441-10</td> <td></td> <td></td> </tr> </table>	silver anodized	10-0444-10			black lacquered	10-0441-10			white lacquered	10-0441-10																																																								
silver anodized	10-0444-10																																																																			
black lacquered	10-0441-10																																																																			
white lacquered	10-0441-10																																																																			
<p>End Caps straight LUMINES FLARO [with hole, without hole]</p>		<table border="1"> <tr> <td colspan="4">Aluminium End Caps left</td> </tr> <tr> <td>silver</td> <td>12-0255-11</td> <td></td> <td></td> </tr> <tr> <td>black</td> <td>12-0000-07</td> <td></td> <td></td> </tr> <tr> <td>white</td> <td>12-0231-11</td> <td></td> <td></td> </tr> <tr> <td colspan="4">Aluminium End Caps with hole left</td> </tr> <tr> <td>silver</td> <td>12-0255-10</td> <td></td> <td></td> </tr> <tr> <td>black</td> <td>12-0922-10</td> <td></td> <td></td> </tr> <tr> <td>white</td> <td>12-0231-10</td> <td></td> <td></td> </tr> <tr> <td colspan="4">Aluminium End Caps right</td> </tr> <tr> <td>silver</td> <td>12-0245-11</td> <td></td> <td></td> </tr> <tr> <td>black</td> <td>12-0000-08</td> <td></td> <td></td> </tr> <tr> <td>white</td> <td>12-0241-11</td> <td></td> <td></td> </tr> <tr> <td colspan="4">Aluminium End Caps with hole right</td> </tr> <tr> <td>silver</td> <td>12-0245-10</td> <td></td> <td></td> </tr> <tr> <td>black</td> <td>12-0932-10</td> <td></td> <td></td> </tr> <tr> <td>white</td> <td>12-0241-10</td> <td></td> <td></td> </tr> </table>	Aluminium End Caps left				silver	12-0255-11			black	12-0000-07			white	12-0231-11			Aluminium End Caps with hole left				silver	12-0255-10			black	12-0922-10			white	12-0231-10			Aluminium End Caps right				silver	12-0245-11			black	12-0000-08			white	12-0241-11			Aluminium End Caps with hole right				silver	12-0245-10			black	12-0932-10			white	12-0241-10				
Aluminium End Caps left																																																																				
silver	12-0255-11																																																																			
black	12-0000-07																																																																			
white	12-0231-11																																																																			
Aluminium End Caps with hole left																																																																				
silver	12-0255-10																																																																			
black	12-0922-10																																																																			
white	12-0231-10																																																																			
Aluminium End Caps right																																																																				
silver	12-0245-11																																																																			
black	12-0000-08																																																																			
white	12-0241-11																																																																			
Aluminium End Caps with hole right																																																																				
silver	12-0245-10																																																																			
black	12-0932-10																																																																			
white	12-0241-10																																																																			
<p>End Caps built-in LUMINES FLARO [with hole]</p>		<table border="1"> <tr> <td colspan="4">Aluminium End Caps with hole left</td> </tr> <tr> <td>silver</td> <td>12-0215-10</td> <td></td> <td></td> </tr> <tr> <td>black</td> <td>12-0212-10</td> <td></td> <td></td> </tr> <tr> <td>white</td> <td>12-0211-10</td> <td></td> <td></td> </tr> <tr> <td colspan="4">Aluminium End Caps with hole right</td> </tr> <tr> <td>silver</td> <td>12-0235-10</td> <td></td> <td></td> </tr> <tr> <td>black</td> <td>12-0222-10</td> <td></td> <td></td> </tr> <tr> <td>white</td> <td>12-0221-10</td> <td></td> <td></td> </tr> </table>	Aluminium End Caps with hole left				silver	12-0215-10			black	12-0212-10			white	12-0211-10			Aluminium End Caps with hole right				silver	12-0235-10			black	12-0222-10			white	12-0221-10																																				
Aluminium End Caps with hole left																																																																				
silver	12-0215-10																																																																			
black	12-0212-10																																																																			
white	12-0211-10																																																																			
Aluminium End Caps with hole right																																																																				
silver	12-0235-10																																																																			
black	12-0222-10																																																																			
white	12-0221-10																																																																			

LUMINES Profile type IPA12					
 			silver anodized	10-0484-10	
			black lacquered	10-0405-10	
			white lacquered	10-0481-10	
LUMINES Profile type IPA16					
 			silver anodized	10-0494-10	
			black lacquered	10-0415-10	
			white lacquered	10-0491-10	
LUMINES Profile type APA12					
 			silver anodized	10-0404-10	
			black lacquered	10-0315-10	
			white lacquered	10-0401-10	
LUMINES Profile type APA16					
 			silver anodized	10-0414-10	
			black lacquered	10-0325-10	
			white lacquered	10-0411-10	
Profil LUMINES type PLATO					
 	 		raw	10-0900-10	
			silver anodized	10-0894-10	
			black lacquered	10-0885-10	
			white lacquered	10-0871-10	
End Caps LUMINES PLATO [push hole]		Plastic End Caps (push hole)			
		silver	12-1024-01		
		black	12-1022-01		
white	12-1021-01				
Profil LUMINES type FALCO					
 	 		raw	10-0940-10	
			silver anodized	10-0934-10	
			black lacquered	10-0925-10	

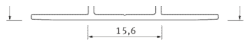

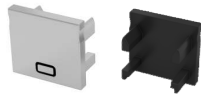

End Caps LUMINES FLACO
[push hole]





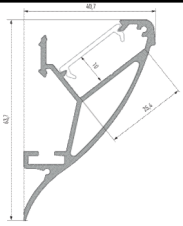
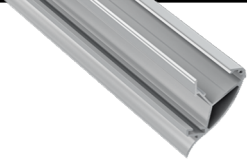

white lacquered	10-0911-10		
Plastic End Caps (push hole)			
silver	12-1034-01		
black	12-1032-01		
white	12-1031-01		

LUMINES Profile type CONVA

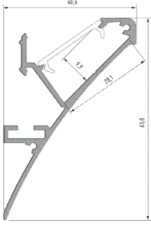
 		<table border="1"> <tr> <td>silver anodized</td> <td>10-0424-10</td> <td></td> <td></td> </tr> <tr> <td>black lacquered</td> <td>10-1335-10</td> <td></td> <td></td> </tr> <tr> <td>white lacquered</td> <td>10-0421-10</td> <td></td> <td></td> </tr> </table>	silver anodized	10-0424-10			black lacquered	10-1335-10			white lacquered	10-0421-10																																																								
silver anodized	10-0424-10																																																																			
black lacquered	10-1335-10																																																																			
white lacquered	10-0421-10																																																																			
<p>End Caps LUMINES CONVA [with hole, without hole]</p>		<table border="1"> <tr> <td colspan="4">Aluminium End Caps left</td> </tr> <tr> <td>silver</td> <td>12-0155-11</td> <td></td> <td></td> </tr> <tr> <td>black</td> <td>12-0152-11</td> <td></td> <td></td> </tr> <tr> <td>white</td> <td>12-0151-11</td> <td></td> <td></td> </tr> <tr> <td colspan="4">Aluminium End Caps with hole left</td> </tr> <tr> <td>silver</td> <td>12-0155-10</td> <td></td> <td></td> </tr> <tr> <td>black</td> <td>12-0152-10</td> <td></td> <td></td> </tr> <tr> <td>white</td> <td>12-0151-10</td> <td></td> <td></td> </tr> <tr> <td colspan="4">Aluminium End Caps right</td> </tr> <tr> <td>silver</td> <td>12-0165-11</td> <td></td> <td></td> </tr> <tr> <td>black</td> <td>12-0162-11</td> <td></td> <td></td> </tr> <tr> <td>white</td> <td>12-0161-11</td> <td></td> <td></td> </tr> <tr> <td colspan="4">Aluminium End Caps with hole right</td> </tr> <tr> <td>silver</td> <td>12-0165-10</td> <td></td> <td></td> </tr> <tr> <td>black</td> <td>12-0162-10</td> <td></td> <td></td> </tr> <tr> <td>white</td> <td>12-0161-10</td> <td></td> <td></td> </tr> </table>			Aluminium End Caps left				silver	12-0155-11			black	12-0152-11			white	12-0151-11			Aluminium End Caps with hole left				silver	12-0155-10			black	12-0152-10			white	12-0151-10			Aluminium End Caps right				silver	12-0165-11			black	12-0162-11			white	12-0161-11			Aluminium End Caps with hole right				silver	12-0165-10			black	12-0162-10			white	12-0161-10		
Aluminium End Caps left																																																																				
silver	12-0155-11																																																																			
black	12-0152-11																																																																			
white	12-0151-11																																																																			
Aluminium End Caps with hole left																																																																				
silver	12-0155-10																																																																			
black	12-0152-10																																																																			
white	12-0151-10																																																																			
Aluminium End Caps right																																																																				
silver	12-0165-11																																																																			
black	12-0162-11																																																																			
white	12-0161-11																																																																			
Aluminium End Caps with hole right																																																																				
silver	12-0165-10																																																																			
black	12-0162-10																																																																			
white	12-0161-10																																																																			

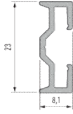
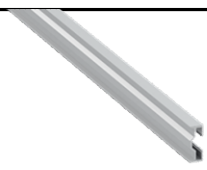

LUMINES Profile type LOGI

 		<table border="1"> <tr> <td>silver anodized</td> <td>10-0504-10</td> <td></td> <td></td> </tr> <tr> <td>black lacquered</td> <td>10-0455-10</td> <td></td> <td></td> </tr> <tr> <td>white lacquered</td> <td>10-0501-10</td> <td></td> <td></td> </tr> </table>	silver anodized	10-0504-10			black lacquered	10-0455-10			white lacquered	10-0501-10																												
silver anodized	10-0504-10																																							
black lacquered	10-0455-10																																							
white lacquered	10-0501-10																																							
<p>End Caps LUMINES LOGI [with hole, without hole]</p>		<table border="1"> <tr> <td colspan="4">Aluminium End Caps left</td> </tr> <tr> <td>silver</td> <td>12-0525-11</td> <td></td> <td></td> </tr> <tr> <td>black</td> <td>12-0000-15</td> <td></td> <td></td> </tr> <tr> <td>white</td> <td>12-0521-11</td> <td></td> <td></td> </tr> <tr> <td colspan="4">Aluminium End Caps with hole left</td> </tr> <tr> <td>silver</td> <td>12-0525-10</td> <td></td> <td></td> </tr> <tr> <td>black</td> <td>12-0522-10</td> <td></td> <td></td> </tr> <tr> <td>white</td> <td>12-0521-10</td> <td></td> <td></td> </tr> <tr> <td colspan="4">Aluminium End Caps right</td> </tr> </table>			Aluminium End Caps left				silver	12-0525-11			black	12-0000-15			white	12-0521-11			Aluminium End Caps with hole left				silver	12-0525-10			black	12-0522-10			white	12-0521-10			Aluminium End Caps right			
Aluminium End Caps left																																								
silver	12-0525-11																																							
black	12-0000-15																																							
white	12-0521-11																																							
Aluminium End Caps with hole left																																								
silver	12-0525-10																																							
black	12-0522-10																																							
white	12-0521-10																																							
Aluminium End Caps right																																								

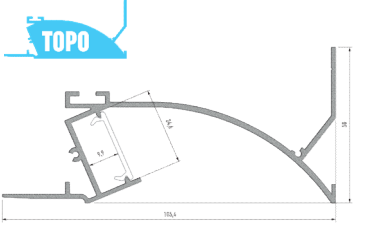
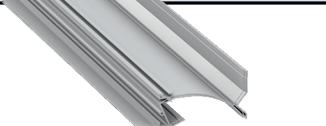
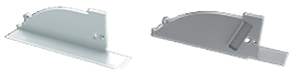

			silver	12-0535-11			
			black	12-0000-16			
			white	12-0531-11			
		Aluminium End Caps with hole right					
			silver	12-0535-10			
			black	12-0532-10			
			white	12-0531-10			
 <p>Mounting profile SPARO for profiles CONVA, LOGI</p>			silver anodized	10-0544-10			

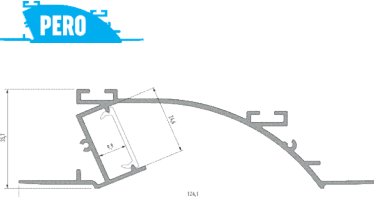
LUMINES Profile type TOPO					
		silver anodized	10-0574-10		
		black lacquered	10-0565-10		
		white lacquered	10-0571-10		
End Caps LUMINES TOPO [with hole]		Aluminium End Caps with hole left			
		silver	12-0855-10		
		black	12-0862-10		
		white	12-0851-10		
		Aluminium End Caps with hole right			
		silver	12-0865-10		
black	12-0852-10				
white	12-0861-10				

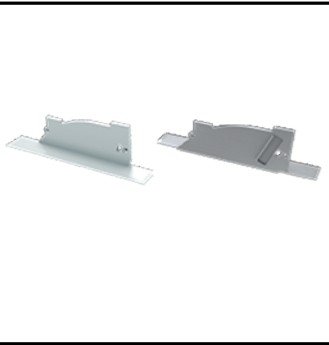
LUMINES Profile type PERO

 <p>PERO</p>		<p>silver anodized</p> <p>10-0514-10</p>		
		<p>black lacquered</p> <p>10-0475-10</p>		
		<p>white lacquered</p> <p>10-0511-10</p>		
<p>End Caps LUMINES PERO [with hole]</p>		<p>Aluminium End Caps with hole left</p>		
		<p>silver</p> <p>12-0555-10</p>		
		<p>black</p> <p>12-0552-10</p>		
		<p>white</p> <p>12-0551-10</p>		
		<p>Aluminium End Caps with hole right</p>		
		<p>silver</p> <p>12-0565-10</p>		
<p>black</p> <p>12-0562-10</p>				
<p>white</p> <p>12-0561-10</p>				

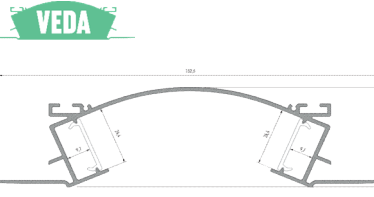

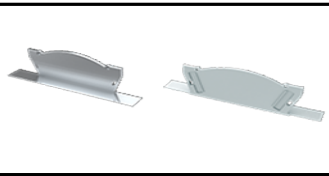
LUMINES Profile type VEDA

 <p>VEDA</p>		<p>silver anodized</p> <p>10-0584-10</p>		
		<p>black lacquered</p> <p>10-0575-10</p>		
		<p>white lacquered</p> <p>10-0581-10</p>		
<p>End Caps LUMINES VEDA [with hole]</p>		<p>Aluminium End Caps with hole</p>		
		<p>silver</p> <p>12-0895-10</p>		
		<p>black</p> <p>12-0902-10</p>		
		<p>white</p> <p>12-0891-10</p>		

ACCESSORIES



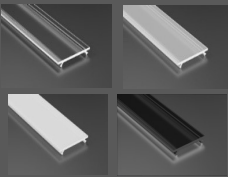
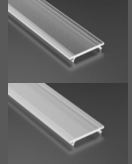
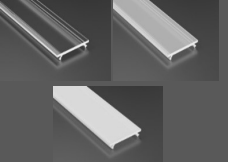
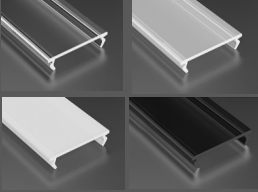
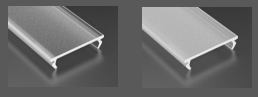
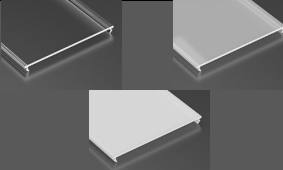
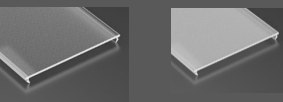
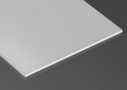

LUMINES COVER

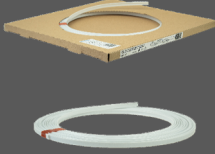
Tolerance levels of the dimension (section length) for covers are
1m ; 2,02m ; 3m is 5mm. For sections over 3m +8mm

Description	Photo	Colour	Index		
Cover LUMINES BASIC PMMA		transparent	11-2013-10		
		frosted	11-2012-10		
		milky	11-2011-10		
		black	11-2017-10		
For profiles [APA12, APA16, IPA12, IPA16, FLARO, MONO, TIANO, GAUDI, FALCO]					
Cover LUMINES BASIC PMMA FROSTED		frosted (available while stocks last)	11-2015-10		
		frosted ML	11-2016-10		
For profiles [APA12, APA16, IPA12, IPA16, FLARO, MONO, TIANO, GAUDI, FALCO]					
Cover LUMINES BASIC PC		transparent	11-3013-10		
		frosted	11-3012-10		
		milky	11-3011-10		
For profiles [APA12, APA16, IPA12, IPA16, FLARO, MONO, TIANO, GAUDI, FALCO]					
Cover LUMINES DOUBLE PMMA		transparent	11-2073-10		
		frosted	11-2072-10		
		milky	11-2071-10		
		black	11-2077-10		
For profiles [SUBLI, ZATI, LOGI, CONVA, TOPO, PERO, VEDA, HIRO, PLATO]					
Cover LUMINES DOUBLE PMMA FROSTED		frosted (available while stocks last)	11-2075-10		
		frosted ML	11-2076-10		
For profiles [SUBLI, ZATI, LOGI, CONVA, TOPO, PERO, VEDA, HIRO, PLATO]					
Cover LUMINES SUPER WIDE PMMA		transparent	11-2093-10		
		frosted	11-2092-10		
		milky	11-2091-10		
For profile [SORGA]					
Cover LUMINES SUPER WIDE PMMA FROSTED		frosted (available while stocks last)	11-2095-10		
		frosted ML	11-2096-10		
For profile [SORGA]					
Cover LUMINES SUPER WIDE PLEXI		PLEXI	11-3091-10		
For profile [SORGA]					
Cover LUMINES TIANO PLEXI		PLEXI	11-3111-10		

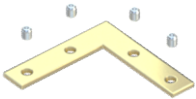
For profile [TIANO]					
LUMINES COVER - 20m packaging					
Description	Photo	Colour	Index		
Cover LUMINES BASIC PMMA - 20m		transparent	11-2043-22		
		frozen	11-2042-22		
		milky	11-2041-22		
For profiles [APA12, APA16, IPA12, IPA16, FLARO, MONO, TIANO, GAUDI, FALCO]		frosted ML	11-2046-22		
Cover LUMINES BASIC PC - 20m		transparent	11-3043-22		
		frozen	11-3042-22		
		milky	11-3041-22		
For profiles [APA12, APA16, IPA12, IPA16, FLARO, MONO, TIANO, GAUDI, FALCO]					

ACCESSORIES

<p>Mounting spring [For profiles inSILEDA, inDILEDA, TALIA M3, TALIA M4, inTALIA, LARGO M3, LARGO M4, TIANO, SUBLI, SORGA, TOPO, PERO, VEDA]</p>		galvanized steel	14-5001-00		
<p>LUMINES Connectors</p>		angular (without allen)	14-3030-01		
		angular (with allen)	14-3031-01		
		straight (without allen)	14-3032-02		
		straight (with allen)	14-3030-02		
		angular cross (without allen)	14-3038-01		
		angular cross (with allen)	14-3039-01		
		angular 120 degree (without allen)	14-3036-01		
		angular 120 degree (with allen)	14-3037-01		

** The profiles and cover are available in sizes: 1000 mm, 2020 mm
 *** Dimensions of 3000 mm and 4000 mm are also available after prior consultation with the distributor

It is possible to cut profiles to any dimension
